

Keep safe



# Continuous Ionized KANGEN WATER® Generator

# Leveluk R

---

## Operation Manual

---

Thank you very much for purchasing The Leveluk R KANGEN WATER® Generator.  
Please follow the instructions in this Operation Manual carefully.  
After reading, keep it in a safe place together with the warranty for future reference.

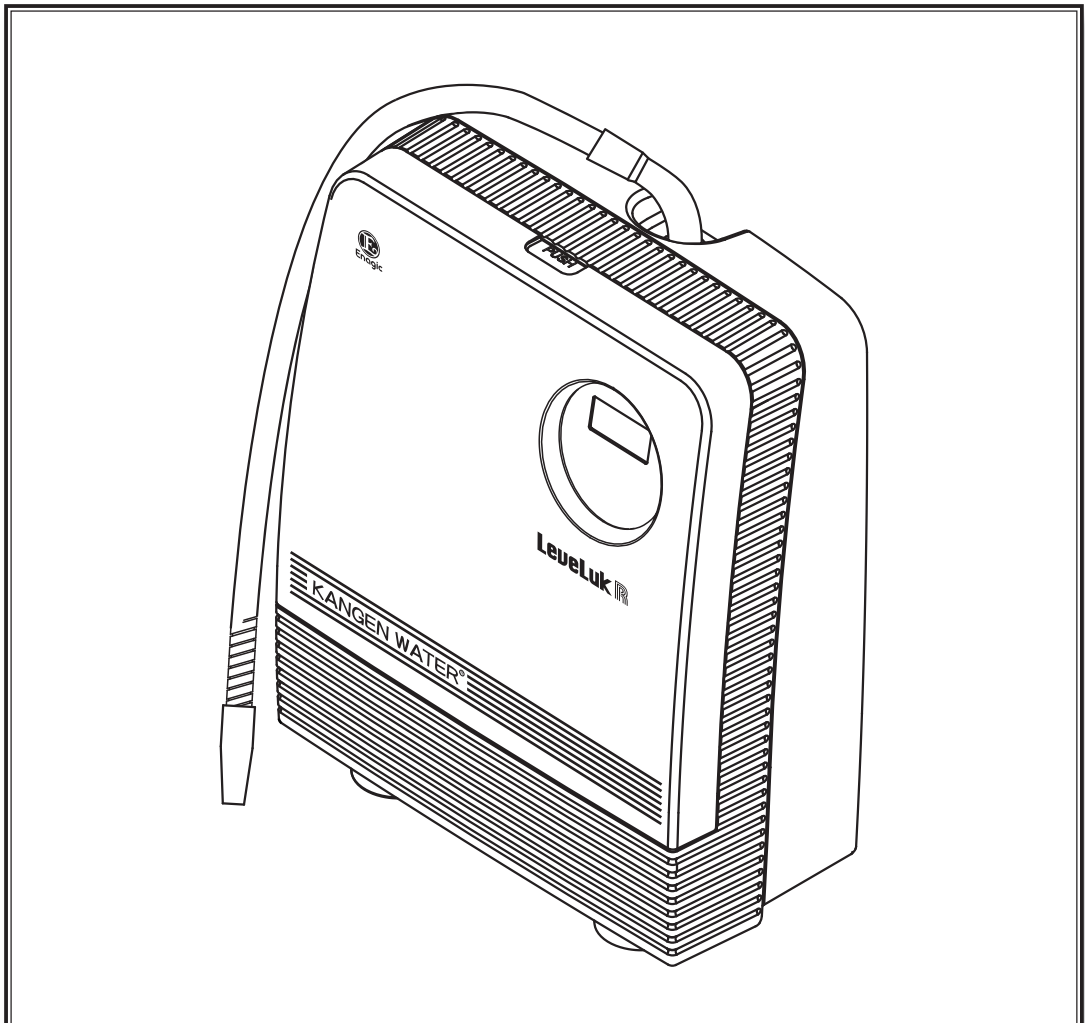

## Los Angeles (US Headquarters)

4115 Spencer Street Torrance, CA 90503 U.S.A.  
tel.1-310-542-7700 fax.1-310-542-1700

## New York

36-36 33rd St. 4th Floor Suite 403 Astoria, NY 11106 U.S.A.  
tel.1-718-784-2110 fax.1-718-784-2103

## Chicago

1154 S. Elmhurst Rd. Mount Prospect, IL 60056-4241 U.S.A.  
tel.1-847-437-8200 fax.1-847-437-8201

## Texas

739 Justin Road, Rockwall, TX 75087 U.S.A.  
tel.1-972-722-7499 fax.1-972-722-7402

## Florida

8803 Futures Drive, Unit01, Orlando, FL 32819 U.S.A.  
tel.1-407-601-5963 fax.1-407-730-3335

## Seattle

19009 33rd Avenue, W., suite 201, Lynnwood, WA 98036 U.S.A.  
tel.1-425-640-2222 fax.1-425-672-8946

## Honolulu

Ala Moana Pacific Center, Suite 711, 1585 Kapiolani Boulevard,  
Honolulu, Hawaii 96814 U.S.A.  
tel.1-808-949-5300 fax.1-808-949-5336

## Vancouver

Suite 678-5900 N0.3 Road Richmond, BC V6X 3P7 Canada.  
tel.1-604-214-0065 fax.1-604-214-0067

## Toronto

75 Watline Avenue, Suite 138 Mississauga, ON L4Z 3E5, Canada.  
tel.1-905-507-1200 fax.1-905-507-1233

## Mexico

Commercial Plaza Tanarah Avenida Vasconcelos 345,  
Colonia Santa Engracia 66267  
San Pedro Garza Garcia, Nuevo Leon, Mexico  
tel.52-81-8242-5500 fax.52-81-8242-5549

## Germany

Immermannstr.33 40210 Düsseldorf Germany  
tel.49-211-9365-7000 fax.49- 211-9365-7027

## France

24 rue du Banquier 75013 Paris France  
tel.33-01-4707-5565 fax.33-01-4707-5595

## Italy

Via roccaporena 40-42 00191 Roma Italy  
tel.39-06-3987-0284 fax.39-06-3987-0287

## Australia

15/33 Waterloo Rd Macquarie Park,  
New South Wales 2113, Australia  
tel.61-2-9878-1100 fax.61-2-9878-1200

## Philippines

21st floor, 6788 Ayala Avenue, Makati Sky Tower,  
Makati City, Philippines  
tel.63-2-519-5508 fax.63-2-519-1923

## Singapore

111 North Bridge Road, 25-04 Peninsula Plaza Singapore 17909  
tel.65-6720-7501 fax.65-6720-7505

## Malaysia

Unit 29-7,7F, The Boulevard Mid Valley City, Lingkaran Syed Putra,  
59200, Kuala Lumpur, Malaysia  
tel.60-3-2282-2332 fax.60-3-2282-2335

## Hong Kong

Unit 1615-17, 16th Floor Miramar Tower, 132 Nathan Rd.,  
Tsim Sha Tsui, Kowloon, Hong Kong.  
tel.852-2154-0077 fax.852-2154-0027

## Taiwan

Nanjing East Road, 3-337 12F B Room  
Xiong Shan Qu, Taipei City, Taiwan  
tel.886-2-2713-2936 fax.886-2-2713-2938

## Korea

7F 118-3, Nonhyun-dong Gangnam-gu Seoul, Korea  
tel.82-2-546-8120 fax.82-2-546-8127

## Sapporo

Regent Building 7F  
1-5, Nishi2chome, Kita2jo, Chuo-ku, Sapporo-city, Hokkaido,  
Japan 060-0002  
tel.81-11-223-5678 fax.81-11-223-5680

## Tokyo

Echizenya Building 7F  
1-1-6, Kyobashi Chou-ku, Tokyo, Japan 104-0031  
tel.81-3-5205-6030 fax.81-3-5205-6035

## Sikoku

1313-8, Simojimayama-kou, Saijyou-city, Ehime, Japan 793-0006  
tel.81-897-58-4115 fax.81-897-58-4116

## Okinawa

4-10-1, Makiminato Urazoe-city, Okinawa, Japan 901-2131  
tel.81-98-878-4132 fax.81-98-878-4141

## Nago

2-15-16, Ohigashi Nago-city, Okinawa, Japan 905-0016  
tel.81-980-51-0616 fax.81-980-51-0628

## Manufacturer:

### Enagic, Inc.

1-40-1, Hosida-kita Katano-city, Osaka, Japan 576-0017  
tel.81-72-893-2290 fax.81-72-893-8007



ISO 9001:2008  
ISO 13485:2003  
Management  
System

www.tuv.com  
ID 9105070879

# ■ IMPORTANT SAFEGUARDS

---

## • READ ALL INSTRUCTIONS BEFORE USING:

**DANGER** – To reduce the risk of electrocution:

1. Always unplug this product immediately after using.
2. Do not use while bathing.
3. Do not place or store product where it can fall or be pulled into a tub or sink.
4. Do not place in or drop into water or other liquid.
5. Do not reach for a product that has fallen into water. Unplug immediately.

**WARNING** – To reduce the risk of burns, electrocution, fire, or injury.

1. A product should never be left unattended when plugged.
2. Close supervision is necessary when this product is used by, or near children or invalids.
3. Use this product only for its intended use as described in this manual. Do not use attachments for other uses not recommended by the manufacturer.
4. Never operate this product if it has a damaged cord or plug, not working properly, has been dropped or damaged, or has been dropped into water. Return the product to a service center for examination and repair.
5. Keep the cord away from heated surfaces.
6. Never use while sleeping or drowsy.
7. Never drop or insert foreign object(s) into any openings or hose(s).
8. Do not use outdoors or operate where aerosol (spray) products are being used or where oxygen is being administered.
9. Connect this product to a properly grounded outlet only. See Grounding Instructions.

# ■ SAVE THESE INSTRUCTIONS

---

- a) This manual contains instructions for cleaning, user maintenance, and proper operations recommended by the manufacturer such as lubrication, and non-lubrication of this device. All services required by this product must be performed by an authorized service representative, which means that this product contains no user serviceable parts. This product is for household use as stated in this manual and other literature packed with the product.
- b) When a product employing an automatic reset thermal limiter (which shuts off the entire product) is used, please refer to this manual for instructions and warnings.
- c) While the product is in use, please refer to this manual for proper cord maintenance.
- d) The product is intended to be used with water, additives, conditioners, or a product that relies on the conductivity of water for normal operations (electrode type products). The use of baking soda, salt, or other substances to improve the conductivity of the water is stipulated. Please refer to this manual for specific instructions on the proper liquid or additive and the exact amount to be used in conjunction with the product.

# ■ GROUNDING INSTRUCTIONS

---

This product should be grounded. In the event of an electrical short circuit, grounding reduces the risk of electric shock by providing an escape wire for the electric current. This product is equipped with a cord having a grounding wire with a grounding plug. The plug must be plugged into an outlet that is properly installed and grounded.

**DANGER** – Improper use of the grounding plug can result in a risk of electric shock.

If repair or replacement of the cord or plug is necessary, do not connect the grounding wire to either flat blade terminal. The wire with insulation with an outer surface that is green with or without yellow stripes is the grounding wire. Check with a qualified electrician or serviceman if the grounding instructions are not completely understood, or if in doubt as to whether the product is properly grounded.

**For all other grounded, cord connected products** : This product is factory equipped with a specific electric cord and plug to permit connection to a proper electric circuit. Make sure that the product is connected to an outlet having the same configuration as the plug. No adapter should be used with this product. Do not modify the plug provided — if it will not fit the outlet, have the proper outlet installed by a qualified electrician. If the product must be reconnected for use on a different type of electric circuit, the reconnection should be made by qualified service personnel.

**Extension Cords** : If it is necessary to use an extension cord, use only a three wire extension cord that has a three-blade grounding plug, and a three-slot receptacle that will accept the plug on the product. Replace or repair damaged cord.





# Contents

Introduction	<b>1</b> Safety Precautions	
	●Description of icons .....	4
Installation	<b>2</b> Parts name and accessories .....	6
	<b>3</b> Installation	
	●Installing the diverter .....	8
Preparations for use	●Installation of body and hose connection .....	9
	<b>4</b> Prior to first usage	
	●Matter of carrying out surely before use .....	11
Usage	/ pH (hydrogen ion) measurement	
	●Use / Indication of liquid crystal .....	12
	<b>5</b> Usage (basic operation).....	13
	■Using KANGEN Water ■Using Beauty Water ■Using Clean Water	
	<b>6</b> Special usage (Use if source water pH is below 7.) .....	16
Improvement	<b>7</b> Disposal after use	
	● Disposal of the product and accessories .....	16
	/ When not in use for an extended period of time please take the following steps to preserve your machine.	
Maintain normal condition	<b>8</b> Handling after use	
	●Automatic cleaning of the ionizing cell .....	17
	/ Cleaning the exterior and diverter / Cleaning the flexible pipe	
In case of being in trouble	●Replacing the water filter .....	18
	●Cleaning with E-Cleaner N(Optional) .....	19
	<b>9</b> Maintenance	
	●Protection notifications / Options .....	21
	●Q & A (Questions and Answers) .....	22
	<b>10</b> Troubleshooting .....	23
	<b>11</b> Standard specifications.....	24
	■ After-sales Service .....	(Back cover)

## ■ Structure of continuous type electrolytic water generator

(Popular name: Continuous Ionized KANGEN Water Generator)





This product has obtained the approval of the generator of matter for medical. This product generates alkaline electrolytic water and acidic electrolytic water by filtering the tap water, making the clean water and doing electrolysis.

※Concerning with "Alkaline electrolytic water" and "Acidic electrolytic water" showing in JIS T2004"Electrolytic water generator for household use", in this manual, we use the technical term of "KAGEN Water" and "Beauty Water".









# 1 Safety Precautions (Please observe.)

## Description of icons













To prevent damage or injury to yourself, others, and property, be sure to observe the following.

 <b>Warning</b>	This indicates possibility of personal injury.	 Prohibited
 <b>Attention</b>	This indicates possibility of damage and or unit failure.	 Extra Caution

## Warning

<p>■ Do not damage the power plug.</p> <ul style="list-style-type: none"> <li>• Use staple gun</li> <li>• Damaged.</li> <li>• Modify</li> <li>• Kinking</li> <li>• Twisting.</li> <li>• Pulling</li> <li>• Expose to excessive heat</li> <li>• Under heavy objects</li> <li>• Bundle</li> <li>• Pinch.</li> <li>• Putting between it</li> </ul> <p>Using a damaged power cord can result in fire, short circuit, and or electric shock.</p> <ul style="list-style-type: none"> <li>● When unplugging the unit, use the plug. Do not pull on the power cord.</li> <li>● Please contact your Customer Service Center for any necessary repairs.</li> <li>● Be sure the power cord is firmly connected.</li> </ul>	<p>■ For use with only rated voltage outlet.</p> <p> Do not use with extension cord.</p>
<p>■ Plug in completely.</p> <p> If the plug is not fully inserted into the outlet it may result in fire, short circuit or electric shock.</p> <ul style="list-style-type: none"> <li>• Do not use a damaged plug or loose outlet.</li> </ul>	<p>■ Do not handle the plug with wet hands.</p> <p> It may result in electric shock.</p>
<p>■ In case the unit falls into water, unplug it before removing it from the water.</p> <p> It causes the electric shock.</p> <ul style="list-style-type: none"> <li>• Please consult to your dealer as to repairing.</li> </ul>	<p>■ Always disconnect the power before cleaning the unit.</p> <p> </p> <ul style="list-style-type: none"> <li>• Disconnect the power if the unit is not in use for an extended period of time.</li> <li>• When dust builds up on the cord, unplug it and wipe clean with a dry cloth.</li> </ul>
<p>■ Never wash the unit or pour water over the unit.</p> <p> Do not wet.</p>	<p>■ Never disassemble, repair or modify.</p> <p> May result in fire or electric shock.</p> <ul style="list-style-type: none"> <li>• Contact your nearest Customer Service Center for any repairs.</li> </ul>
	<p>■ Only use water from an approved drinking water source i.e. tap water.</p> <p></p> <ul style="list-style-type: none"> <li>• This unit does not sterilize the water.</li> <li>• Do not use salt water or extremely hard water.</li> </ul>

# Attention

<p>■ Consult your physician before drinking KANGEN Water if any of the following pertain to you.</p> <ul style="list-style-type: none"> <li>● You are under a physician`s care.</li> <li>● You have a chronic illness or are physically weak</li> <li>● You have any kidney problems.</li> </ul> 	<p>■ Do not drink KANGEN Water if you have kidney failure and/or trouble of processing potassium.</p> 
<p>■ Do not take medication with KANGEN Water.</p> <ul style="list-style-type: none"> <li>● Do not use KANGEN Water with baby formula or baby foods.</li> </ul> 	<p>■ Do not drink water with a pH greater than 10.0.</p> <ul style="list-style-type: none"> <li>● Adjust the pH of KANGEN Water to 9.5 or lower.</li> </ul> 
<p>■ If the following explanation describes your condition, please consult your physician before using Beauty Water.</p> <ul style="list-style-type: none"> <li>● Delicate skin</li> <li>● Allergies</li> </ul> 	<p>■ If after drinking KANGEN Water, you experience any discomfort, please stop drinking KANGEN Water and see your physician.</p> 
<p>■ Discontinue use of Beauty Water if you experience any reactions and consult with your physician.</p> <ul style="list-style-type: none"> <li>● Use Beauty Water within 2 days of production.</li> </ul> 	<p>■ Use KANGEN Water as soon as possible after generation.</p> <ul style="list-style-type: none"> <li>● KANGEN Water may be kept in an airtight container for up to 24 hours at room temperature and up to 3 days in the refrigerator.</li> </ul> 
<p>■ Do not drink following water:</p> <ul style="list-style-type: none"> <li>● Beauty Water</li> <li>● Water flowing from secondary water hose</li> <li>● Water during cleaning</li> </ul> 	<p>■ Do not use KANGEN Water, Beauty Water or Clean water in fish bowls or aquariums.</p> <p>Change in pH may kill fish.</p> 
<p>■ DO not use water above 35°C/95F</p> <ul style="list-style-type: none"> <li>● The damage or malfunction can occur</li> </ul> 	<p>■ The start of use pours the stagnant in equipment.</p> <ul style="list-style-type: none"> <li>● When using the equipment first or new water filter, use it after letting water flow for at least 3 minutes.</li> <li>● As the first time of daily use, use it after letting water flow for at least 10 seconds.</li> <li>● When not using it for several days, use it after letting water flow for at least 30 seconds.</li> </ul> 
<p>■ Do not use aluminum containers being alkaline-sensitive and copper containers acidity-sensitive.</p> <p>The container changes color or is damaged.</p> 	

# ⚠ Attention

● **Never place anything on the unit.**

- It may fall over. -



● **Do not use the unit when the secondary water hose is in an elevated position.**

- Water cannot flow out of the unit and therefore it may cause damage. -

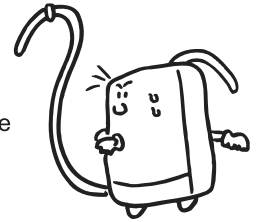

● **Avoid direct sunlight.**

- May cause the unit to bend or warp. -

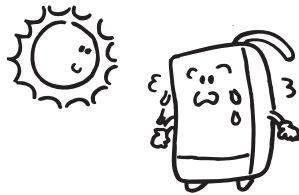

● **Do not use salt water or excessively hard water.**

- The unit may be damaged, or its service life will be shortened. -

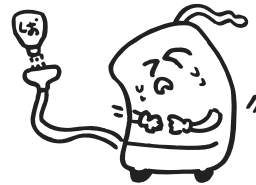

● **Please supervise children and senior citizens while they use the machine.**

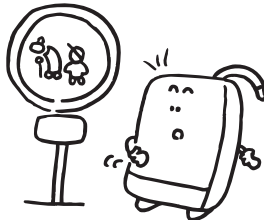

● **Do not place the unit near hot objects or in the presence of corrosive gas.**

- May damage or cause the unit to bend or warp. -

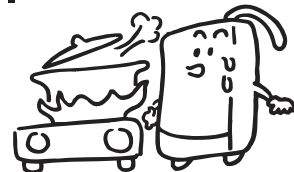

● **Do not use thinner, benzene, cleansers or chlorine-based detergents for cleaning.**

- May damage the unit. -



● **When using the machine in an area with cold temperatures please avoid running freezing water into the unit (When you are not using the unit for a long period of time, remove the water filter and store it where it will not freeze. Do not touch the Reset button).**

- Failure to do so can result in damage or malfunction. -



Please observe

## 2 Parts name and accessories

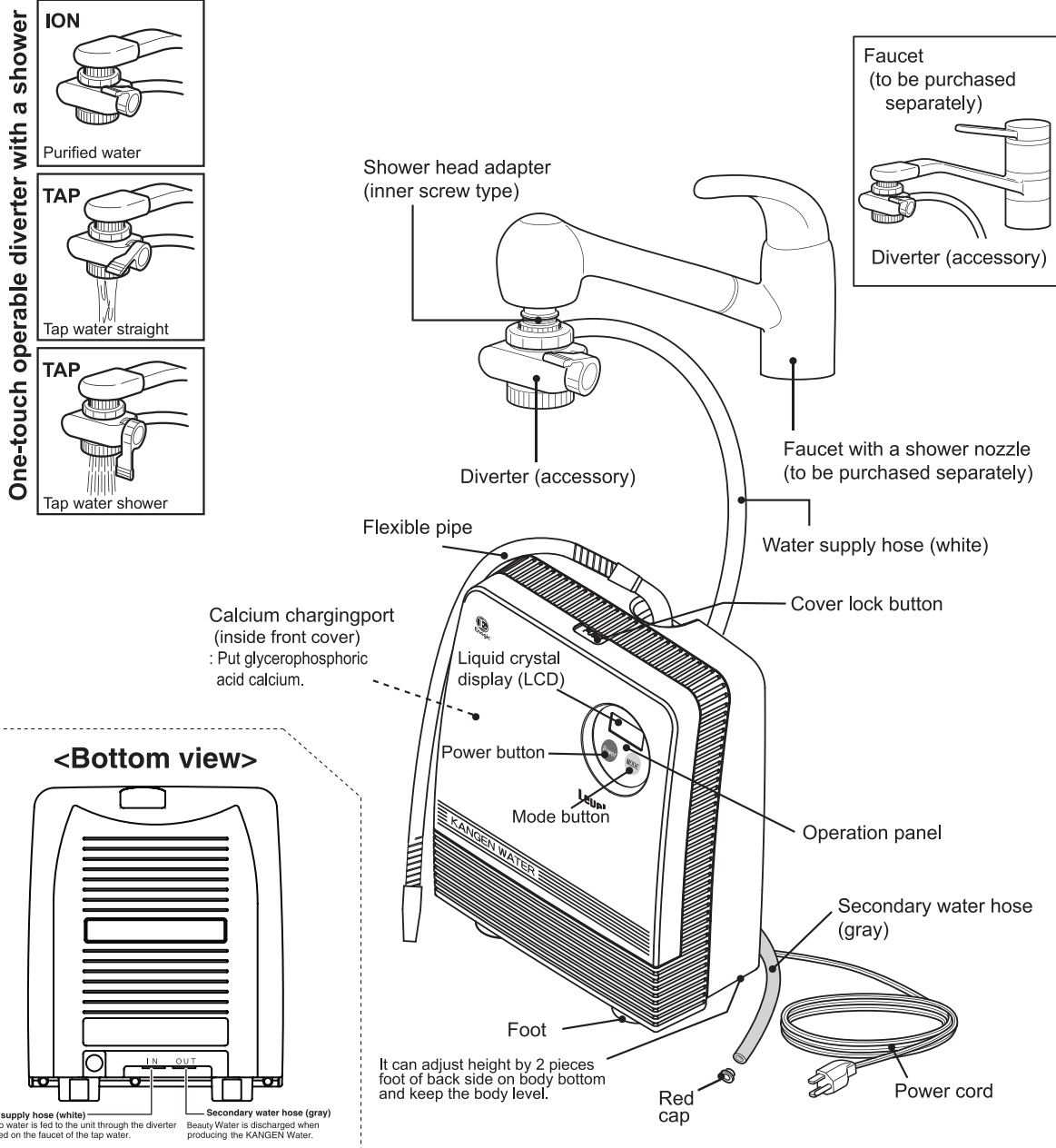

### Accessories

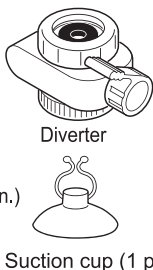
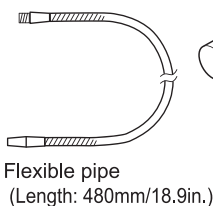

### About installation

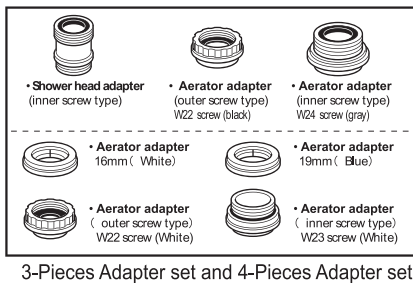

### About the usage

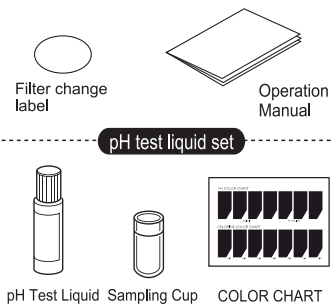

# 3 Installation

## Installing the diverter

The diverter may fail to fit on some types of faucets. Check the type of faucet beforehand. Then fit the diverter on the faucet in the specified manner.

### How to mount One lever faucet

#### Inner screw type

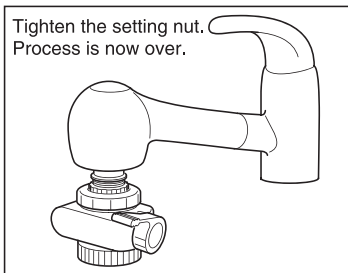
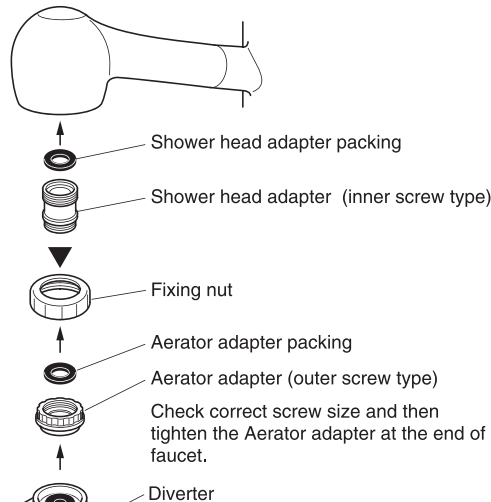
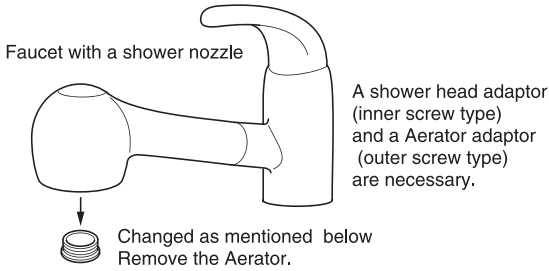

#### Outer screw type

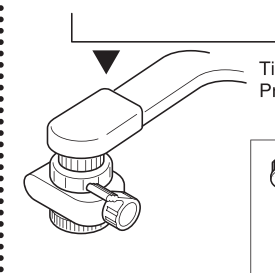
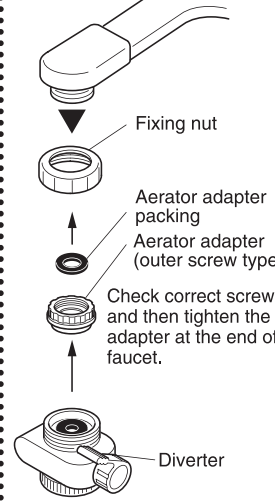
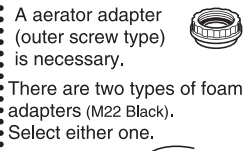

#### Inner screw type

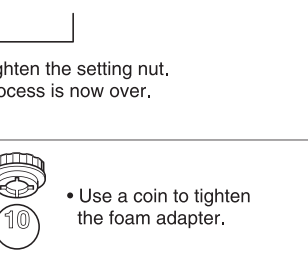
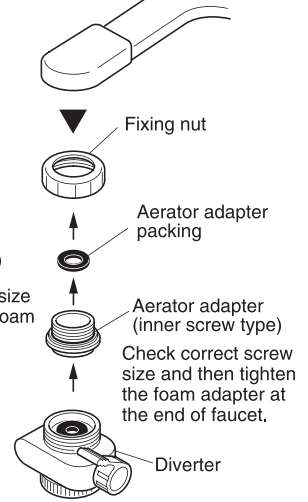
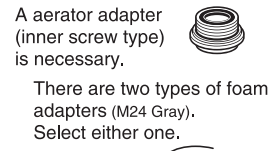
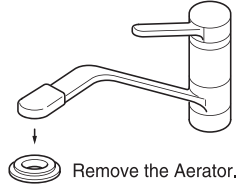

• Use a coin to tighten the foam adapter.



If the thread diameter or thread pitch does not fit, the threads may get damaged. Make sure the thread diameter and pitch are as specified.

**The faucets shown at right cannot accept the diverter.**

With a sensor	Screw diameter does not match	Faucet whose noggle part is short.	Square faucets
	<p>•When the accompanying adapter does not fit.</p> <p>φ 0.88inch / φ 22mm is OK</p>	<p>0.4inch / 10mm or smaller</p>	

In this case, add a dedicated faucet or install the specific diverter. For details, contact your dealer.

# Installation of body and hose connection

## ■ Install according to the order (1 to 4).

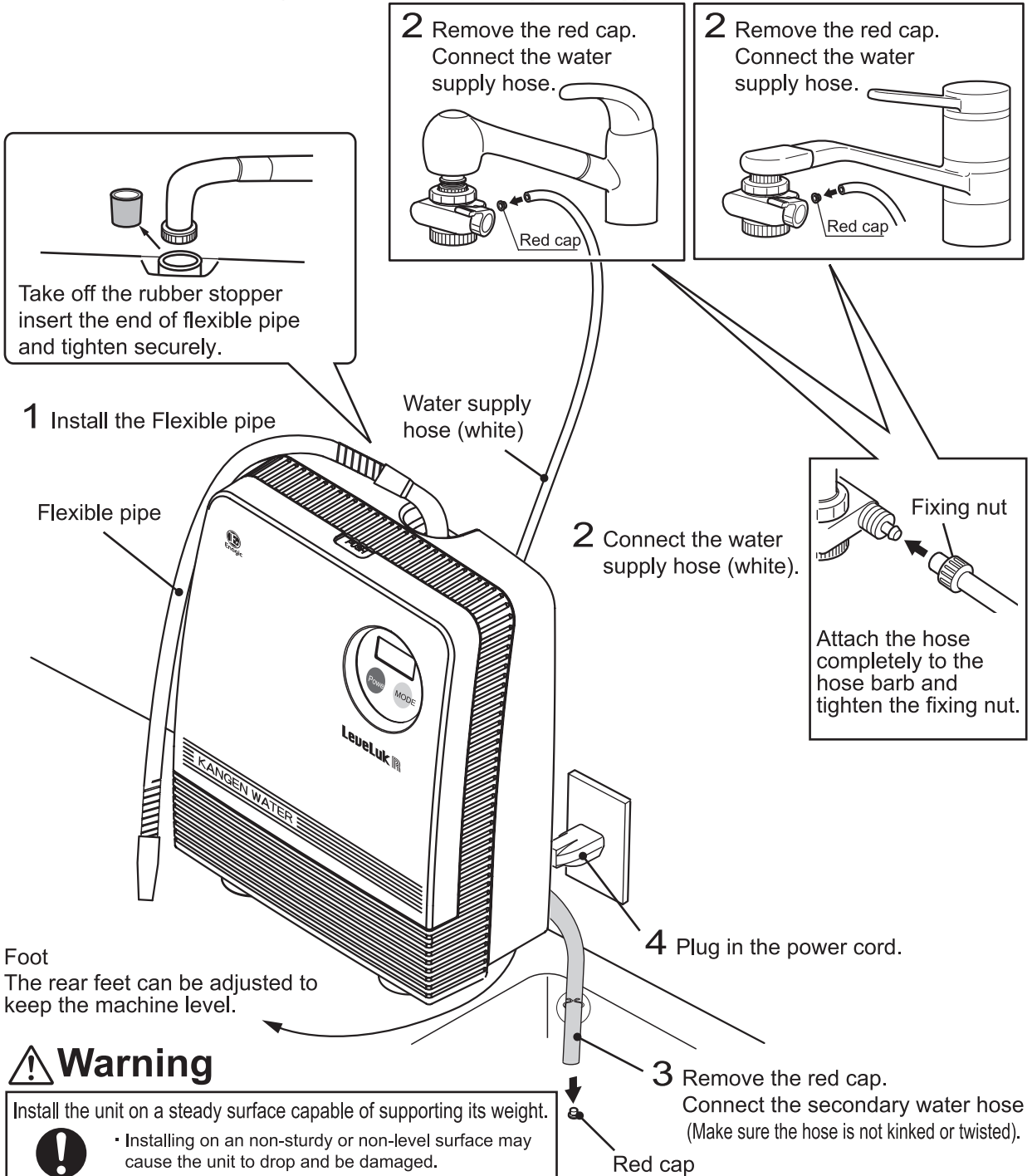

### ⚠ Warning

Install the unit on a steady surface capable of supporting its weight.



- Installing on a non-sturdy or non-level surface may cause the unit to drop and be damaged.

Do not install in the following manners.



- Place near flame
- Place in direct sunshine
- Place that is exposed to the elements
- Place with potential to freeze
- Place exceeding the room temperature 40°C/104°F and humidity 90%
- Place of poor ventilation

### ⚠ Attention

Do not place any objects on the machine.



- It may cause damage or fall.



## About the power cable

■ Please use the outlet of AC120V · 60Hz (USA) / AC220—240V · 50/60Hz (Europe / Some parts of Asia) for household use.

※Using improper voltage will void the warranty.

### Warning



Prohibited

- Never bend, pull, twist, or bundle the power cord. Do not lay heavy objects on top of the cord or clamp the cord: This may damage the cord, and cause electric shock that may lead to hazardous fire.
- Do not use a damaged power cord or loosely fitted one. It may cause electric shock, short circuit or fire.
- Stapling the power cord is strictly prohibited. This will cause irreparable damages to the cord and possibly fire.
- Do not plug too many plugs into one outlet.
- When cleaning the outlet, first disconnect the power plug. Dust on outlets can cause fire.
- Connect or disconnect the power plug by holding the plug instead of the cord. Pulling the cord can cause breakage, fire, and/or electric shock.
- Use only the proper power supply/ voltage. Using improper power source/voltage can cause fire or electric shock.
- If the power cord gets damaged do not attempt to repair it yourself. Contact your local dealer to arrange for repairs.

### Attention



Please observe

- Please be sure that the power cord can be easily unplugged prior to use.
- Be sure to check that all buttons work properly.
- Please bundle the cord during to storage to avoid damage.



- A wet plug can cause electric shock.  
If the power plug is severely wet
  - (1) Disconnect the plug from the outlet
  - (2) Wipe the water off the plugs
  - (3) Consult your local dealer for repairs
- Never handle power plugs with wet hands. If power plug is wet, first disconnect it completely from the outlet and wipe it dry. Failure to follow these procedures may result in electric shock.
- Always unplug this product after use.



## 4 Prior to first usage

### Matter of carrying out surely before use

1. Confirm if operation button, switch and LCD operate normally.
2. Do the selector lever of diverter to purified water side and supply water.
  - Confirm that the water pours from flexible pipe and secondary water hose at Clean Water mode.
3. As it stands, do initial supply water more than 3 minutes at Clean Water mode.
  - ※ Dump the water to let the air out of the water filter and body inside.
  - ※ Confirm that the water drips from each connection part.
  - ※ During initial supply of water the produced water may appear slightly cloudy. (The cloudiness is caused by air and carbon fines contained in the water filter. Use the water only when the cloudiness disappears.)
4. At the start of use, measure the pH value and confirm that the water is the potable range.

### pH (hydrogen ion) measurement

- This pH test liquid is the matter to measure standard pH value.
- The pH value is graduated a little according to the local water characteristics.

#### pH value measuring method

- There is some difference of strength of pH value according to the district.



**1. Put KANGEN Water in the included test tube about 0.8inch deep.**

- The pH value is unsteady in water initially processed. Therefore, flow the water for approximately 10 seconds before sampling.

COLOR CHART

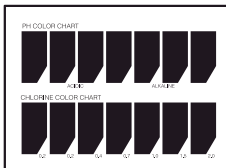

**2. Add about 1-2 drops of pH Test Liquid in the cup and shake the contents well.**

**3. Compare the color of the water in the test tube with that of the Color Chart paper and check the pH concentration.**

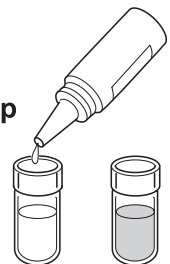

### ⚠ Attention



- Do not drink the water in the test tube after testing.
- Do not drink or put pH test liquid in eyes or keep away from fire.
- Store the testing liquid out of children's reach.



- Keep the testing liquid in a cold and dark place leaving capped.
- At the start of use, measure the pH value and confirm that the water is the potable range. After installing or in case of not using for long time, measure the pH value and confirm that the water is the potable range. Measure it periodically (more than once per 1 month) since.

# Use / Indication of liquid crystal

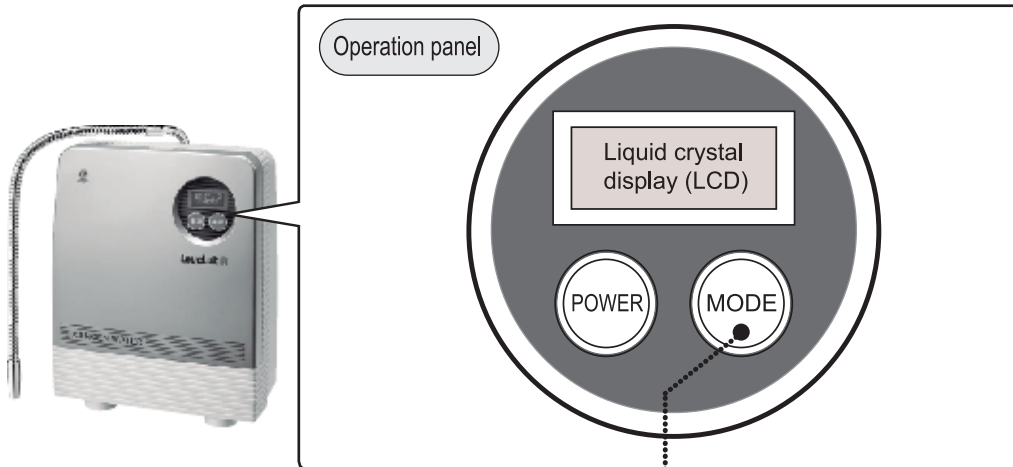

LCD	Indication	KANGEN 1	KANGEN 2	KANGEN 3	BEAUTY	CLEAN
	Color	Light blue	Blue	Purple	Yellow	Green
	Sound	—	—	—	Audio Notification	—
	Use	<b>Maintaining your health</b> This pH level is recommended for people to get used to KANGEN Water.	<b>Making green tea or coffee and cooking rice</b> Your green tea or coffee will taste mellow, and your rice will cook soft and full.	<b>Making herb tea, mild herb tea</b> Most suitable for making barley water or oolong tea.	<b>For your skin care</b> To be used as astringent water, bath water.	<b>To be taken with medicine or added to powdered baby milk</b> This Clean Water can be used as water to be taken with medicine as well as water you can drink every day.
	Drinking	○ ※	○ ※	○ ※	×	○
	Processed water	KANGEN Water			Beauty Water	Clean Water
	pH level	8.5	9.0	9.5	6.0~6.5	7.0

※...Not to be used with medicine. When taking medicine, select the Clean Water mode.

## Indication necessitated correspondence and operation

Protection error/Water filter replacement/Cleaning Audio Notification

● See each page

HOT RUN PROTECT	HEAT PROTECT	INCREASE FLOW	DECREASE FLOW	➔	P.21
REPLACE FILTER	➔	P.18	CLEANS	➔	P.17

## 5 Usage (basic operation)

### KANGEN Water, Beauty Water and Clean Water common

■ This processor operates in one-touch to process **KANGEN Water**, **Beauty Water** and **Clean Water**

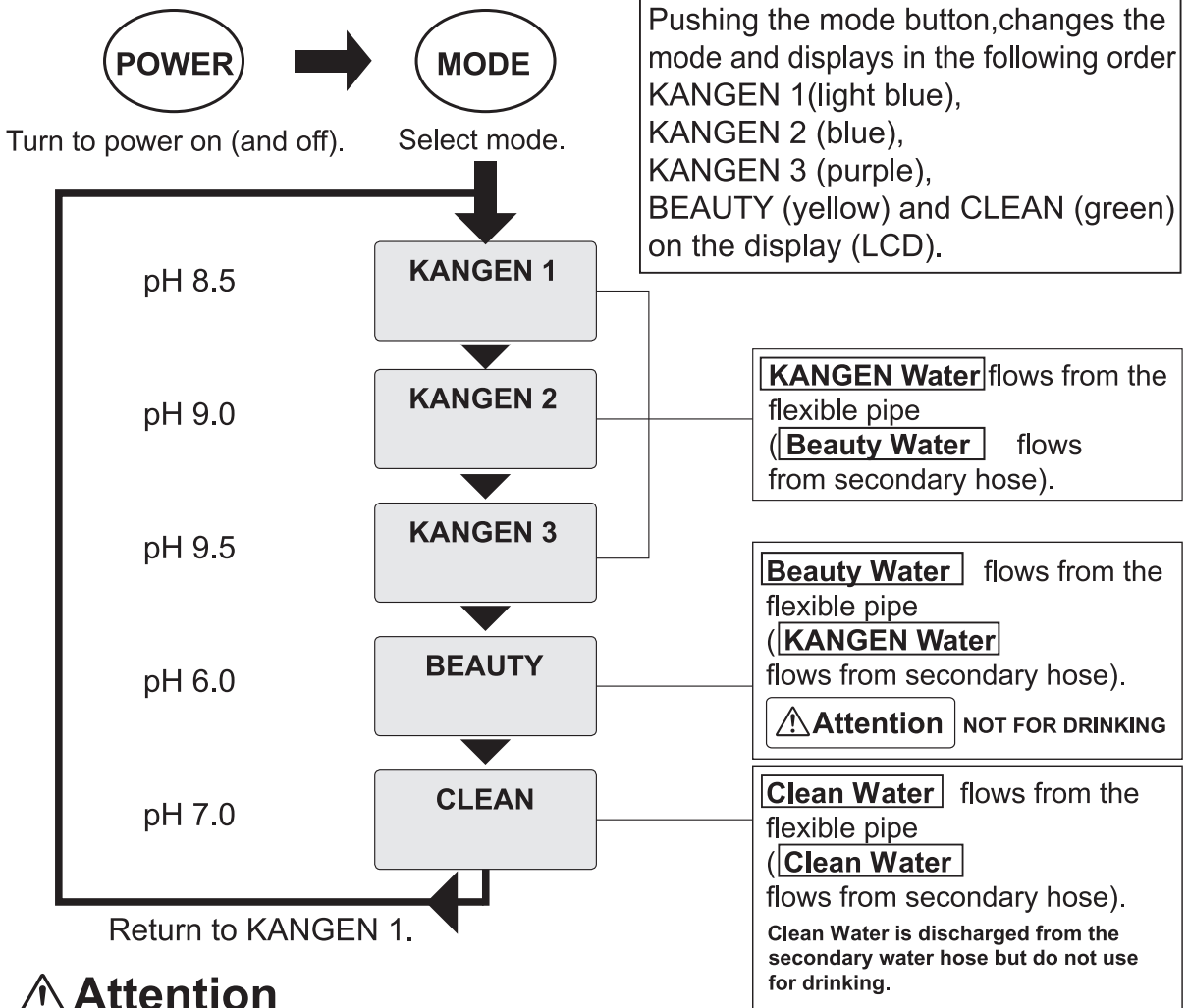

### **Attention**

- Do not drink the water flowing from secondary water hose in all these modes.
  - When using the equipment for the first time or new water filter, use it after letting water flow for at least 3 minutes.
  - The first use of the day, allow water to flow for at least 10 seconds.
  - When not using it for several days, use it after letting water flow for at least 30 seconds.
- To prevent backflow, do not submerge the tip of the flexible pipe in the container of water.
  - When collecting water from the secondary hose, be sure to keep the end of the hose lower than the unit to allow the water to flow freely.

# Using KANGEN Water

Press the **POWER** button to turn on the power.

- When turning on the power, the mode is displayed.

Display (LCD)

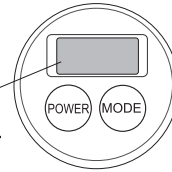

Pressing the mode button, select "KANGEN 1", "KANGEN 2" and "KANGEN 3".

- Every pressing the button, the changeover of KANGEN Water 1, 2 and 3 is possible.

Color of the liquid crystal display (LCD)

KANGEN 1 (light blue)

KANGEN 2 (blue)

KANGEN 3 (purple)

Display (LCD)

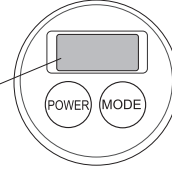

① Set the lever of the diverter to **ION** then turn on the water.



Diverter

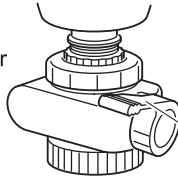

Lever ION position

② Processed water will be discharged.

- **KANGEN Water** is discharged from the flexible pipe.
- Beauty Water is discharged from the secondary water hose.

Flexible pipe

**KANGEN Water**

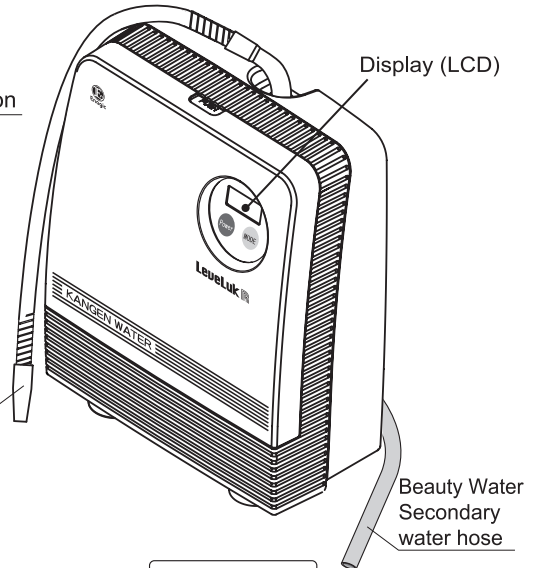

**Caution**

**NOT FOR DRINKING**

■ How to stop operation

- Turn off the faucet to stop production of water.

# Using Beauty Water

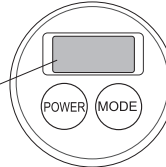
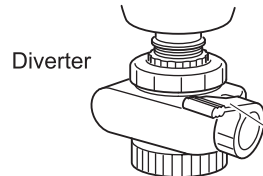
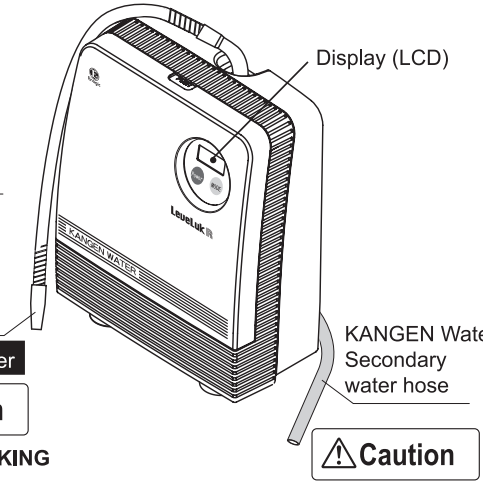
1	<p>Press the <b>POWER</b> button to turn on the power.</p> <ul style="list-style-type: none"> <li>When turning on the power, the mode is displayed.</li> </ul>	
2	<p>Select "BEAUTY" by the mode button.</p>	
3	<p>① Set the lever of the diverter to <b>ION</b> then turn on the water.</p>  <p>↓</p> <p>② Processed water will be discharged.</p> <ul style="list-style-type: none"> <li><b>Beauty Water</b> is discharged from the flexible pipe and beeping sound will be made when water is produced.</li> <li>KANGEN Water is discharged from the secondary water hose.</li> </ul>	

# Using Clean Water (filtered water)

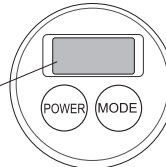
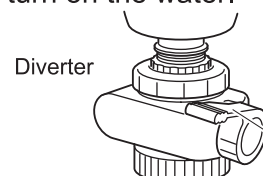
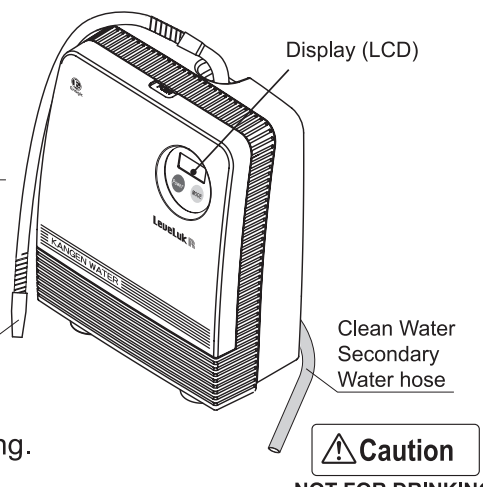
1	<p>Press the <b>POWER</b> button to turn on the power.</p> <ul style="list-style-type: none"> <li>When turning on the power, the mode is displayed.</li> </ul>	
2	<p>Select "CLEAN" by the mode button.</p>	
3	<p>① Set the lever of the diverter to <b>ION</b> then turn on the water.</p>  <p>↓</p> <p>② Processed water will be discharged.</p> <ul style="list-style-type: none"> <li><b>Clean Water</b> is discharged from the flexible pipe.</li> <li>Clean Water is discharged from the secondary water hose but do not use for drinking.</li> </ul>	

## 6 Special usage (use if source water pH is below 7.)

### For adding glycerophosphoric acid calcium/Options

Measure the pH, (see to page 9) if source water pH is below 7, add glycerophosphoric acid calcium.

If source water pH is 7 or above, you do not need to use it.

- ※ Glycerophosphoric acid calcium increases the calcium concentration in the KANGEN Water (The calcium is added all KANGEN Water, Beauty Water and Clean Water).
- ※ The calcium will help raise the source water pH.

#### How to add

1. Close the faucet, remove the front cover and take out the calcium adding cylinder (by turning counterclockwise).  
(See the drawing below.)
2. Clean the adding cylinder and cap with water.  
(If calcium remains in inside, remove it with water.)
3. Fill it to about 80% volume of the total cylinder capacity.
4. Return the cylinder and cap to its original position and replace the front cover.

**Request** When not in use for an extended period of time please remove any remaining calcium.

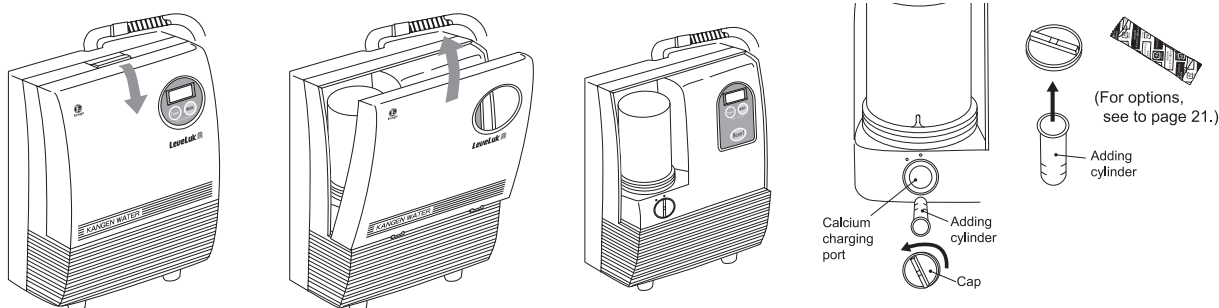

## 7 Disposal after use

### Disposal of the product and accessories

Please following local regulations when disposing of used items.

#### When not in use for an extended period of time please take the following steps to preserve your machine.

- Remove the remaining glycerophosphoric acid calcium (if used).
- Remove out the water filter, drain any remaining water and store it in the refrigerator.
- Turn off the power and unplug the machine.
- When ready to use again, reinstall the filter, plug in the machine and run the water for at least 30 seconds and check for any leaks.

Please replace the filter if it has not been used for a month or more.

## 8 Handling after use

### Automatic cleaning of the ionizing cell

#### Automatic cleaning

Calcium deposited on the electrode in the ionizing cell may result in degraded electrolysis ability. This unit automatically cleans the electrodes to maintain optimum performance.

#### Cleaning frequency

- The unit will automatically clean itself after 15 minutes of use (total from all modes), or 24 hours of no usage.

#### Automatic cleaning process

Once the notice of cleaning is shown, run the water and the machine will clean itself for 30 seconds then return to the previous setting.

- ※ Do not stop the water while the unit is cleaning. Doing so will reset the cleaning mode unit it has fully finished cleaning.
- ※ The machine will not go into the cleaning mode while water is running. Once the water is stopped the unit will notify you of the cleaning mode and clean itself the next time the water is run.

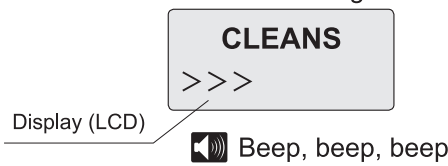
1	<p>&lt;Cleaning mode notification&gt;</p>  <p>Display (LCD)</p>	<ul style="list-style-type: none"><li>● Current setting and 'NOTICE CLEANING' will alternate on the screen.</li></ul>
2	<p>&lt;During the cleaning process &gt;</p> <p>&lt;Water running&gt;</p>  <p>Display (LCD)</p> <p>Beep, beep, beep</p>	<ul style="list-style-type: none"><li>● The unit will notify you of the cleaning process after 15 minutes of use (total from all modes), or 24 hours of no usage.</li><li>● Once the announcement of cleaning is made, the unit will start cleaning automatically for 30 seconds once the water is run through the unit.</li></ul>

### Cleaning the exterior and diverter

To clean the exterior of the unit, use a soft damp cloth. Use a toothbrush to clean the diverter.

#### Warning

 Never pour water or wash the body in water.

#### Attention

 Do not use cleansers, thinner, benzene, alcohol, or kerosene.

### Cleaning the flexible pipe

Remove the dirt of the tip of flexible pipe by soft sponge. Use the optional E-Cleaner N to remove build up from inside the flexible pipe. (see page 19)



# Replacing the water filter

## ⚠ Attention



Be sure to turn off the water and power before replacing the water filter.

### Filter replacement notification

- The unit will notify you when to replace the filter with on screen display and a beeping sound.
- ※ While the water filter is being replaced, the unit adds up the water flow rate of filtered water by water filter and measures even correct replacing time.

## ■ Replacing the water filter

### 1 Remove the filter cover.

- Unlock the holder by pushing the cover lock button on the surface of body and tilt the front cover diagonal ahead 20° to 30°

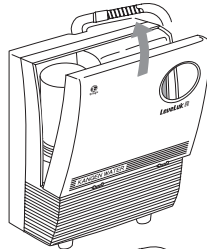

- Raise with tilting condition and remove the front cover.

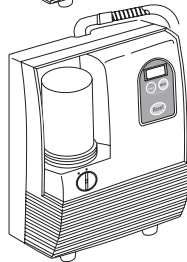

### 2 Turn the holder knob clockwise. Lift and take out the water filter.

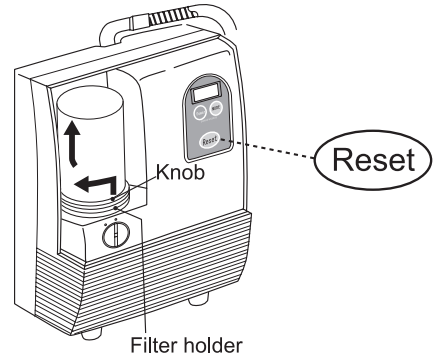

### 3 Make sure the old filter's O-rings are not in the filter tray.

Remove remaining O-ring.

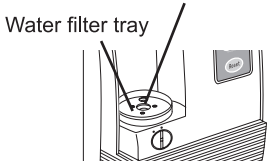

<O-ring actual size>

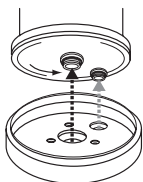
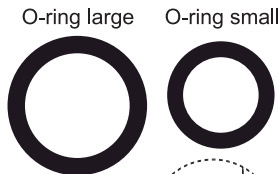

O-ring large

Install

Holder

Water filter for replacement

O-ring small

### 5 After the replacement of water filter, turn on the power, press and hold the reset button until you hear a beep and the display shows 'FILTER RESET'. (about 3 seconds)

### 6 Reinstall the filter cover and run the water for at least 3 minutes or until the water is clear.

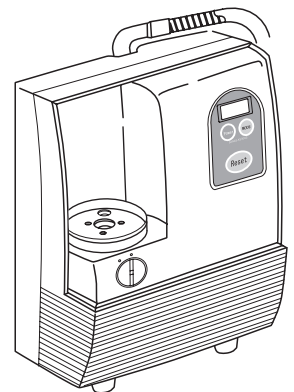

## ⚠ Attention



- Be sure to use our genuine water filter to replacement.
- When using the equipment at first time or using the new water filter, use it after supply of water more than 3 minutes. (During initial supply of water the produced water may appear slightly cloudy. The cloudiness is caused by extra amount of activated carbon contained in the water filter. Use the water only when the cloudiness disappears.)
- Please execute that the spent water filter (combustibles) observe the regulations of the region.



# Cleaning with the E-Cleaner N / Options

Cleaning Powder Unit (CPU-N)  
 (※Replace when CPU-N is broken.)

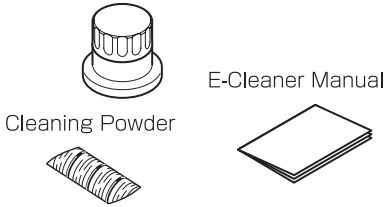

## ⚠ Attention

Please use the cleaning powder once every week or two weeks.

- Be sure to shut off the faucet and turn off the unit before cleaning.
- Always turn the power off and disconnect the plug.
- Please only use one pack of the cleaning powder fabricated by the manufacturer for each individual treatment. Using another cleaning powder could cause internal damage to the unit.

The cleaning powder includes citric acid so avoid using the water during cleaning mode to sanitize all fruits and vegetables.

### Cleaning machine

- Use E-CleanerN once every week to two weeks. -

We recommend deep cleaning once a year at a qualified service center. Deep cleaning intervals may vary, depending on hardness of source water. Water softener is recommended only for extremely hard water sources.

① Unscrew the cap of the CPU-N (Cleaning Powder Unit), pour the cleaning powder evenly into the bottom, and retighten the cap.

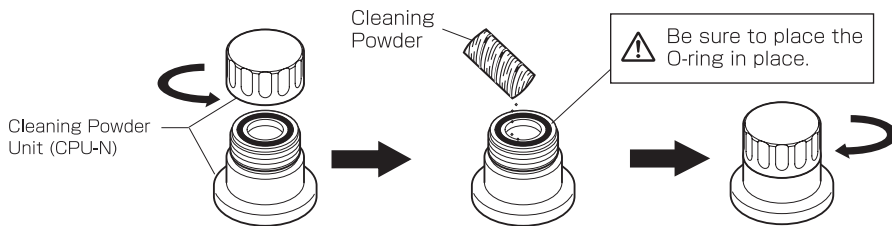

② After turning off the water faucet, remove the filter cover from the main unit, rotate the holder and remove the water filter.

⚠ Always turn the power off and disconnect the plug.

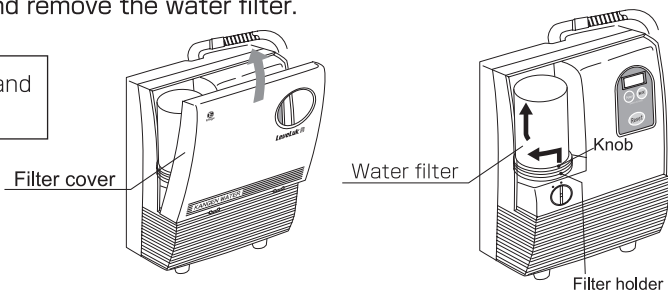

③ Place the cleaning powder unit on the main unit, and secure the unit in place with the holder.

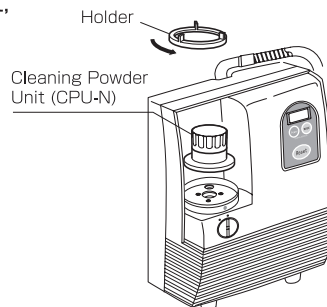

④ Turn on the faucet to allow the water to flow through the flexible pipe for approximately 10 seconds (approx. 1 liter), then turn off the water.

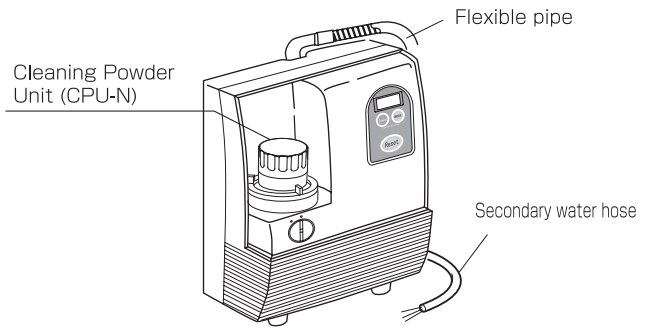

⑤ Place the tip of the flexible pipe and secondary water hose/secondary water stand at the bottom of a cup, and allow the water to flow through the pipe until the cup is half-full of water. Turn off the faucet, and leave the pipe and hose in the cup for three to five hours.

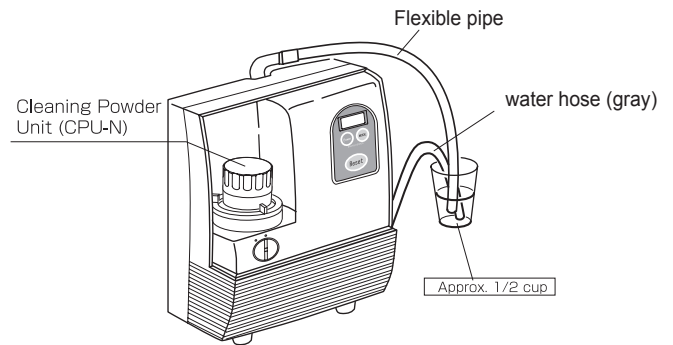

⚠ Be sure the cup does not tip over.

⑥ Remove the cup after three to five hours. Turn on the faucet and allow water to flow through for several minutes.

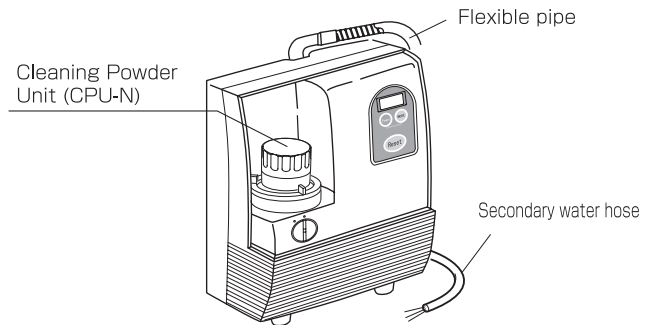

⑦ **Turn off the faucet**, and then replace the water filter that was removed in step ②. Turn on the faucet and allow water to flow through for several minutes.

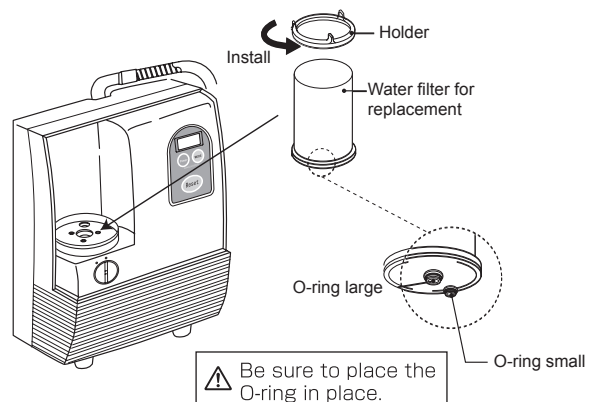

⚠ Be sure to place the O-ring in place.

# 9 Maintenance

## Protection notifications

Protection error, water filter replacement and cleaning  Buzzer sound (Peep, peep, peep)

### HOT RUN PROTECT

The unit senses the hot water by sensor and informs by warning sound.

Operation



Stop the hot water use immediately. Run cold water until "HOT RUN PROTECT" disappears. Use with water temperature of 95F / 35°C or less.

### HEAT PROTECT

The unit senses the installed environment or the rise of temperature in body and informs by warning sound.

Operation



Stop the water, turn off the power source and wait about 30 minutes. (Depending on the use environment, it takes more than 30 minutes.)

### REPLACE FILTER

The unit informs you when to replace the water filter.

Operation



Be sure to replace with our genuine new water filter (option).

### CLEANS

The unit informs you when the automatic cleaning of the electrode in the ionizing cell by sound.

Correspondence



Run the water until the CLEANS notification disappears (about 30 seconds).

Flow rate notification  Buzzer sound (Pip, pip, pip)

### INCREASE FLOW

When the flow rate of the water is too slow when making KANGEN water, the machine notifies you by sound.

Operation



Increase the water flow.

### DECREASE FLOW

When the flow rate of the water is too fast when making KANGEN water, the machine notifies you by sound.

Operation



Decrease the water flow.

## Options

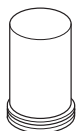

- ① Water filter for replacement (Activated charcoal type) HG-N



- ② Glycerophosphoric acid calcium (3g x containing 12pcs.)

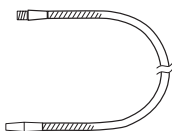

- ③ Flexible pipe (length: 800mm/31.5in.)

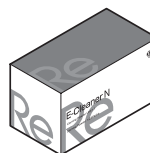

- ④ E-Cleaner N Cleaning powder unit (CPU-N) (It is used over and over.) Cleaning powder (containing 24 pieces)



- ⑤ Cleaning powder (containing 24 pieces)

## Q & A (Questions and Answers)

Q Is the automatic cleaning alone enough?	A Calcium deposits build up not only on the plates but also on the flexible pipe as well. Using the E-Cleaner N (sold separately) is highly recommended.
Q When should I change the filter?	A The machine keeps count of how many gallons have gone through your filter and will notify you when it is time for a replacement. Due to variances in source water some filters may need to be changed more frequently than others.
Q Is the filter available on the open market?	A Filters are only sold through our company. We cannot guarantee performance when the machine is used with a third party filter.
Q Why does pH vary according to flow rate?	A pH varies according to your water source. Adjust the flow rate to increase or decrease the pH in accordance with your source water.
Q What is Glycerophosphoric acid calcium?	A It is an FDA approved food additive and is recognized as being safe.
Q When should I use glycerophosphoric calcium?	A Measure the pH of your source water, if the pH is less than 7 use the calcium. If it is 7 or above do not use the calcium. (see page 9 for pH measurement)
Q What should I do if I have hard water?	A In the beginning of the day run Beauty water for a few minutes. This will help reduce the calcium build up.
Q What water should I not use?	A Do not use the well water containing salt such as seawater.
Q After I replaced the filter the display still says to replace the filter.	A With the power on, press and hold the reset button until you hear a beep.
Q What causes filters to have a shorter life span?	A Using water high in sediment and or rust particles will shorten the life span of your filter.
Q What happens if I run hot water through the machine by accident?	A A little hot water is fine, stop the hot water as soon as you notice and run cold water through the machine as soon as possible.
Q What kind of water is good for babies and little children?	A As the babies and little children are immature compared with adult, we recommend drinking "Clean Water".

# 10 Troubleshooting

• Use the following guide to self check your problem before contacting the company.

Trouble	Cause	Remedy
No power is supplied. (Power lamp doesn't come on.)	• Unit is not plugged the outlet.	• Insert the power plug into the outlet.
Alam sound.	• Defective condition present.	• Follow the instruction on LCD display.
No water comes out. Output of all types of water is getting low.	• The inside the unit is frozen.	• Raise the room temperature and wait until it melts.
	• Water flow (pressure) is low.	• Open the faucet wider.
	• Water filter has clogged.	• Replace the water filter with a new one.
	• Cleaning timing.	• Clean using a E-Cleaner N.
	• The hose is bent.	• Smooth out the hose not to be bent.
Nasty odor or taste.	• KANGEN Water pH concentration is too high.	• Lower the pH concentration.
	• Such odor or taste is coming from the water remaining inside.	• Flow Let the water for a while and completely drain the water inside the tank.
KANGEN Water has chlorine odor.	• Water filter needs to be replaced.	• Replace the water filter with a new one.
Whitish material is floating or has setting in KANGEN Water.	• Calcium processed by electrolysis.	• Change over to Beauty water and let the water flow for a few minutes.
	• Cleaning timing.	• Clean using a E-Cleaner N.
The inside of secondary water hose is stained dark.	• Oxidizing material, such as iron has adhered.	• Harmless.
Dropping pH value when processing KANGEN Water and Beauty Water.	• Calcium buildup in the ionizing cell.	• Select "BEAUTY" by the mode button and run water for about 1 minute to clean the ionizing cell.
	• Cleaning timing.	• Clean using a E-Cleaner N.

# 11 Standard specifications

<b>Item name</b>		<b>Leveluk<sup>®</sup></b>		
<b>General name</b>		Continuous Ionized Water Generator		
<b>Power supply</b> <b>Reted current</b>		( USA ) AC120V 60Hz 1.1A ( Europe / Parts of Asia ) AC220-240V 50/60Hz 1.0A		
<b>Power consumption</b>		Approx.100W(If production is done at KANGEN 3 Water pH level)		
<b>Main unit</b>	<b>Dimensions</b>	(W)250×(H)308×(D)135 mm / (W)9.8×(H)12.1×(D)5.3 in.		
	<b>Weight</b>	Approx. 6.2kg / 13.7lb		
<b>Supplying water specification</b>		3 levels changeover of purified water, tap water shower and tap water straight with diverter		
<b>Applicable water quality</b>		Tap water (appreciate water for drinking)		
<b>Applicable water pressures</b>		50kPa ~ 450kPa		
<b>Continuous use max. water temperature</b>		5~35°C / 41~95°F		
<b>Electrolysis</b>	<b>Quantity of discharge water</b>	2.6 L / min (Feed water pressure: on 100kPa) 0.6gal / min		
	<b>Electrolysis capacity settings</b>	5 levels	KANGEN Water at 3 levels (Approx. pH8.5 / pH9.0 / pH9.5)	1.5 ~ 5.5 L / min 0.3 ~ 1.2gal / min
			Clean Water	0 ~ 5.5 L / min 0 ~ 1.2gal / min
			Beauty Water	1.5 ~ 4.5 L / min 0.3 ~ 1.0gal / min
	<b>Cleaning system of ionizing cell</b>	Automatic cleaning system		
<b>Materials of electrode</b>	Titanium + Plated platinum			
<b>Filter</b>		HG-N		
<b>Water filter</b>	<b>Filter material</b>	Granulated antibacterial activated charcoal, calcium sulfite		
	<b>Removable substance</b>	Residual chlorine(sterilizer),odor,and rust up to 1500 gallons.		
	<b>Un-removable substance</b>	Metal ion / salt dissolved in original tap water		
	<b>Replacement interval</b>	Varies according to region and water quality		
<b>Protective device</b>	<b>Power device</b>	fuse 250V 3A		
	<b>Protection of temperature</b>	Hot water protection, Overheat protection		

- Specifications and design subject to change for product improvements without notice.
- The electrolytic processing capacity and the filter service life largely depend on the water quality or how the machine used.



# After-sales Service

## Warranty

•Please keep the included warranty in a safe place for future reference.

## If you need repair during warranty period

•For repairs, please contact your local dealer.

(Please read the warranty carefully, some repairs may not be covered under the warranty.)

**⚠ Attention** \*You may be charged if your repair is for any of the following reasons.

1. Trouble resulting from handling in a manner that is not specified in the "Operation Manual".
2. Trouble or damage due to the use of water other than municipal drinking water.
3. Trouble or damage due to natural disaster, such as, earthquake, fires or floods.
4. Dropping the product or damage caused during transportation.
5. Damage caused by use of improper voltage.
6. Replacement of consumable parts.
7. Replacement of spent electrode.
8. Trouble resulting from improper usage or failure to perform regular maintenance.
9. Trouble resulting from tampering or altering.
10. Trouble caused by sediment or lime scale deposits.

## If you need to repair after warranty expiration

•Contact your local dealer. Repair may be available upon request at purchaser's expense.

## Others

•If you have any questions about the product, please contact your dealer.

For use with cold water only.

Do not use with water that is microbiologically unsafe or of unknown quality without adequate disinfection before or after the system.

## ⚠ Warning



In no case should the product be modified, overhauled or repaired by purchaser, as fire or electrical shock could result.

Any consequences of such behavior shall not be compensated by the maker.

\* For questions and information, please contact your local dealer.

### Los Angeles (US Headquarters)

tel.1-310-542-7700 fax.1-310-542-1700

### New York

tel.1-718-784-2110 fax.1-718-784-2103

### Chicago

tel.1-847-437-8200 fax.1-847-437-8201

### Texas

tel.1-972-722-7499 fax.1-972-722-7402

### Florida

tel.1-407-601-5963 fax.1-407-730-3335

### Seattle

tel.1-425-640-2222 fax.1-425-672-8946

### Honolulu

tel.1-808-949-5300 fax.1-808-949-5336

### Vancouver

tel.1-604-214-0065 fax.1-604-214-0067

### Toronto

tel.1-905-507-1200 fax.1-905-507-1233

### Mexico

tel.52-81-8242-5500 fax.52-81-8242-5549

### Germany

tel.49-211-9365-7000 fax.49-211-9365-7027

### France

tel.33-01-4707-5565 fax.33-01-4707-5595

### Italy

tel.39-06-3987-0284 fax.39-06-3987-0287

### Australia

tel.61-2-9878-1100 fax.61-2-9878-1200

### Philippines

tel.63-2-519-5508 fax.63-2-519-1923

### Singapore

tel.65-6720-7501 fax.65-6720-7505

### Malaysia

tel.60-3-2282-2332 fax.60-3-2282-2335

### Hong Kong

tel.852-2154-0077 fax.852-2154-0027

### Taiwan

tel.886-2-2713-2936 fax.886-2-2713-2938

### Korea

tel.82-2-546-8120 fax.82-2-546-8127

### Sapporo

tel.81-11-223-5678 fax.81-11-223-5680

### Tokyo

tel.81-3-5205-6030 fax.81-3-5205-6035

### Sikoku

tel.81-897-58-4115 fax.81-897-58-4116

### Okinawa

tel.81-98-878-4132 fax.81-98-878-4141

### Nago

tel.81-980-51-0616 fax.81-980-51-0628

Manufacturer:

**Enagic, Inc.**

tel.81-72-893-2290 fax.81-72-893-8007

Made in Japan.

2013.0

46-0038B